

# Catalogue

|                      |       |    |
|----------------------|-------|----|
| Summary              | ----- | 1  |
| Safety Standards     | ----- | 1  |
| Safety Signs         | ----- | 1  |
| Cautions             | ----- | 2  |
| Packing List         | ----- | 3  |
| Instrument Schematic | ----- | 3  |
| Instructions         | ----- | 6  |
| Automatic Shutdown   | ----- | 13 |
| Precision Indicators | ----- | 13 |
| Technical Indicators | ----- | 17 |
| Maintenance          | ----- | 18 |
| Battery Replacement  | ----- | 19 |

## Summary

The digital AC clamp meter is a stable, safe and reliable instrument. The circuit of the instrument takes integrated circuit as the core and is equipped with a full range overload protection circuit. It has a novel appearance and can be used to measure AC current, AC/DC voltage, temperature, frequency, resistance, capacitance, diode and open-closed circuit measurement. It is a superior instrument special for electricians.

## Safety Standards

This instrument is designed and manufactured according to the safety standards IEC61010-1 and IEC61010-2-032 for electronic measuring instruments and hand-held current clamp meters, and meets the safety standards of double insulation CAT III 600V and pollution position 2.

## Safety Signs



Warning sign, requiring operation with caution.



Can be used on dangerous live conductors.



Double insulation protection (Class II).



Conform to European Union (EU) standards.



Grounding.

## Cautions

- Please read the instructions carefully before using the instrument, and pay special attention to the contents of "⚠". Please follow the operating instructions of "⚠".
- Ensure that the instruments and probes coming with the package meet the requirements of safety standards. If the probe is damaged, replace it with a probe of the same model or electrical specification.
- Before use, check the instrument and probes. If the probe is exposed, the housing is damaged, and the display is abnormal, do not measure.
- When measuring, do not tap the unused input terminal.
- When the measuring voltage is higher than 60V DC or 30V AC, be careful and remember to keep your fingers behind the hand shelter of the probe.
- When the range of to-be-measured value is uncertain, set the function range to the maximum range position. Do not exceed the input limits specified for each range.
- Do not measure a voltage higher than the allowable input value.
- Before switching the function range switch, the probe shall leave the circuit under test.
- Before conducting in-circuit resistance measurement, cut off the power supply and release all charges at both ends of all capacitors.
- Do not expose the instrument to strong light, high temperature or humidity.
- Do not tap bare wires, connectors or circuits being measured with bare hands.

## Packing List

- Operation manual x 1
- Probes x 2
- Temperature probe x 1
- Packing box x 1
- 1.5V SIZE AAA batteries x 3

## Instrument Schematic

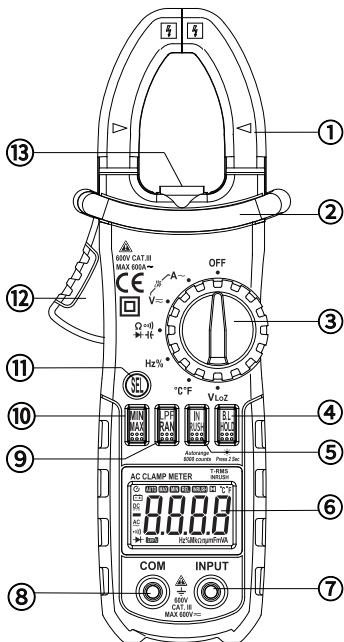

## 1. AC current clamp

Used for sampling AC current.

## 2. Safety barrier

Effectively keep the operator from accidentally taping the live conductor during the current measurement

## 3. Function range switch

Used for selecting various functions and range positions.

## 4. Data-hold /Backlight-display button

- Tap the "BL/HOLD" button, the final reading will be maintained on the display and "  " is displayed. Tap the "BL/HOLD" button again, and the instrument will return to the normal measurement state.
- Press and hold the "BL/HOLD" button for about 2 seconds to turn on or off the LCD backlight, and it will turn off automatically after about 30 seconds.

## 5. Inrush current test button

- Tap the "INRUSH" button to turn on or off the inrush current measurement function
- Press and hold the "INRUSH" button for more than 2 seconds to turn on or off the lights.

## 6. LCD display

Maximum display value: 5999.

## 7. INPUT terminal

In addition to the AC current, the red probe contacts positive input terminals.

## 8. COM terminal

In addition to the AC current, the black probe contacts negative input terminals.

## 9. Manual range /Low-pass filter button

- Tap the "LPF/RAN" button during the automatic range to switch to the manual range.
- Press and hold this key for more than 2 seconds during the manual range to switch back to the automatic range.
- During the AC current and AC voltage automatic measuring, press and hold the "LPF/RAN" button for about 2 seconds to turn on or off the LPF mode.

## 10. Maximum/Minimum value button

- When at the voltage, current, resistance and temperature positions, tap the "MIN/MAX" button to switch between displaying the maximum and minimum values.
- Press and hold the "MIN/MAX" button for more than 2 seconds to exit the maximum and minimum value measurement.

## 11. Function selection button

- In "**A**~" position, it is used to switch between current value and current frequency.
- In "**V**≈" position, it is used to switch between the frequency of AC voltage, DC voltage and AC voltage.
- In " $\frac{\Omega}{\text{diode}}$ " position, it is used for switching between resistance, capacitance, diode measurement and open-closed measurement.

- In "Hz%" position, it is used to switch between frequency and duty ratio.
- In "°C °F" position, It is used to switch between the temperature units of °C and °F.
- In "VLoZ" position, it is used to switch between DC voltage and AC voltage.

## 12. Trigger

Press the trigger and the clamp opens: release the trigger and the clamp automatically closes.

## 13. Clamp meter light

- Press and hold the "INRUSH" button for more than 2 seconds to turn the light on or off.
- The light turns off automatically about 1 minute after it is turned on.

## Instructions



### WARNING

Do not measure any voltage higher than 600V DC or 600V AC RMS to avoid electric shock and/or damage to the instrument. Do not apply voltage exceeding 600V DC or 600V AC RMS between the common terminal and the ground to prevent electric shock and/or damage to the instrument.

## AC and DC voltage measurement

Insert the red probe into the "INPUT" jack, and the black probe into the "COM" jack. Switch the function range switch to "  $V_{\approx}$  " position, tap the "SEL" button to switch between AC voltage, DC voltage and frequency measurement modes, and connect the probes to the measured signal.

### 1. AC voltage and frequency measurement

- When measuring AC voltage, tap the "SEL" button to switch the display of the voltage value and frequency of the measured voltage;
- Tap the "LPF/RAN" button to switch the range of AC voltage.
- When in the AC voltage automatic measurement, press and hold the "LPF/RAN" button for about 2 seconds to turn on or off the LPF filter function. The filter attenuation frequency point is about -0.94dB at 1kHz.

### 2. DC voltage measurement

Connect the probes to the measured signal, the polarity of the terminal connected to the red probe is displayed on the display. Read the measurement results.



#### Caution:

- △ If the measured voltage range is unknown in advance, please set the function range switch to the maximum range, and then gradually reduce the range until a satisfactory resolution is achieved.
- △ When measuring high voltage, pay special attention to avoid electric shock.



## AC current measurement

Switch the function range switch to the current position, hold the trigger, open the clamp, and clamp a wire of the circuit to be tested. The instrument will display the measured current value.

1. Tap the "**SEL**" button to switch to display the frequency of current measurement.
2. Tap the "**LPF/RAN**" button to switch the AC current range
3. During AC voltage and current automatic measurement, press and hold the "**LPF/RAN**" button for more than 2 seconds to turn on or off the LPF measurement function.
4. Tap "**INRUSH**" button to start the inrush current measurement function.



### Caution:

- △ It is impossible to measure if clamping multiple wires at the same time.
- △ If the measured current range is unknown in advance, please set the function range switch to the maximum range, and then gradually reduce the range until a satisfactory resolution is achieved.



## Resistance measurement

1. Insert the red probe into the "**INPUT**" terminal and the black probe into the "**COM**" terminal.
2. Set the function range switch to " $\Omega$ " position, tap the "**SEL**" key to switch to " $\Omega$ " function, and connect the probe to the measured resistance.
3. Read the measurement result after the reading is stable.



### Caution:

- △ When the measured resistance value exceeds the maximum range, the instrument with higher range shall be selected.
- △ When checking the in-circuit resistance, the power supply of the circuit to be tested must be cut off and all capacitors must be fully discharged.
- △ When measuring the resistance above  $1M\Omega$ , it may take several seconds for the reading to become stable, which is normal for high resistance measurement.

## Diode measurement

1. Insert the red probe into the "INPUT" terminal and the black probe into the "COM" terminal. At this time, the polarity of the red probe is "+" and the polarity of the black probe is "-".
2. Set the function range switch to the " $\Omega$   " position.
3. Tap the "SEL" button to switch to the " " position, and the red probe is connected to the anode of the tested diode, and the black probe is connected to the cathode of the tested diode.
4. Read the approximate value of forward voltage drop of the tested diode.

## Circuit continuity measurement

1. Insert the red probe into the "INPUT" terminal and the black probe into the "COM" terminal;
2. Set the function range switch to the " $\Omega$   " position.
3. Tap the "SEL" button to switch to " " position, and the

probe is connected to two points of the circuit to be tested. If the built-in buzzer makes a noise, it means that the conduction resistance between the two points is not greater than  $30 \Omega$ .

## Capacitance measurement

1. Insert the red probe into the "INPUT" terminal and the black probe into the "COM" terminal.
2. Set the function range switch to the " $\Omega$ " position, press the "SEL" button to switch to the " $\text{F}$ " position, and connect the probes to both terminals of the measured capacitance.
3. Read the measurement result after the reading is stable.



### Caution:

- △ When the measured capacitance value exceeds the maximum range, the instrument with higher range shall be selected.
- △ Capacitance cannot be directly measured on the line. The capacitance shall be taken out and fully discharged before measurement.
- △ When measuring the polar capacitance, the red probe is connected to the positive terminal of the capacitance.
- △ When measuring capacitance above  $100 \mu\text{F}$ , it may take several seconds for the reading to be stable, which is normal for large capacitance measurement. When measuring large capacitance, fully discharge the capacitance to improve the measurement accuracy.

## Frequency and duty ratio measurement

1. Insert the red probe into the "INPUT" terminal and the black probe into the "COM" terminal;

2. Set the function range switch to the **Hz%** position, and tap the "**SEL**" button to switch to display the frequency or duty ratio of the measured signal.
3. Connect the probes to both ends of the power supply or load for measurement.
4. Read the frequency or duty ratio of the measured signal.

## Temperature measurement

1. Set the function range switch to the "**°C °F**" position. At this time, the LCD displays the current ambient temperature. Tap the "**SEL**" button to switch the temperature unit between °C or °F.
2. When thermocouple is required to measure temperature insert the red probe of K-type thermocouple into the "**INPUT**" terminal and the black probe into the "**COM**" terminal, and use the thermocouple probes to contact the measured object or area for measurement.
3. Read the measured temperature value.

## Low impedance AC/DC voltage measurement

1. Set the function range switch to "**VLoZ**" position.
2. Tap the "**SEL**" button to switch between AC and DC voltage measurement modes and connect the probes to the measured signal.



### Caution:

- △ **When measuring low impedance voltage, the maximum measurement time shall not exceed 1 minute, and intervals between measurements shall be more than 20 seconds to avoid burning-out caused by excessive heating of load resistance.**

## Automatic Shutdown

When there is no operation within 10 minutes after startup, the instrument will enter the sleep state and automatically shut down to save power. After the automatic shutdown, tap the "SEL" button, and the instrument will start up and enter the working state again.

## Precision Indicators

- Accuracy:  $\pm$  (% reading + digits).
- Warranty period: 1 year from the date of delivery.
- Working environment temperature: 18 °C~28 °C.
- Working environment humidity: no greater than 75%.
- Temperature coefficient:  $0.1 \times$  accuracy/ $1^{\circ}\text{C}$ .

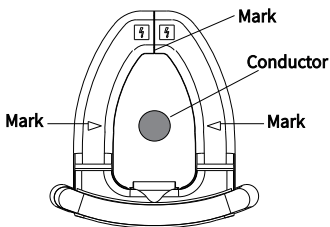

### Caution:

When measuring AC current, please place the conductor to be measured in the center of the clamp. If not, the position error of 1.5% to the maximum can be increased.

**DC voltage**

| Range | Resolution | Accuracy                  |
|-------|------------|---------------------------|
| 6V    | 0.001V     | ± (0.5% reading+3 digits) |
| 60V   | 0.01V      |                           |
| 600V  | 0.1V       |                           |

Input impedance: 10MΩ.

Maximum allowable input voltage: 600V DC or 600V AC RMS.

**AC voltage**

| Range | Resolution | Accuracy                  |
|-------|------------|---------------------------|
| 6V    | 0.001V     | ± (0.8% reading+5 digits) |
| 60V   | 0.01V      |                           |
| 600V  | 0.1V       |                           |

Input impedance: 10MΩ.

Measuring frequency range: 40Hz~1000Hz.

Maximum allowable input voltage: 600V DC or 600V AC RMS.

**AC current**

| Range | Resolution | Accuracy                  |
|-------|------------|---------------------------|
| 6A    | 0.001A     | ± (2.5% reading+5 digits) |
| 60A   | 0.01A      |                           |
| 600A  | 0.1A       |                           |

Minimum input value of AC current: 0.01A (RMS)

Maximum input value of AC current: 600A (RMS)

Frequency range: 40Hz~1000Hz

## Resistance

| Range | Resolution | Accuracy                  |
|-------|------------|---------------------------|
| 600Ω  | 0.1Ω       | ± (1.0% reading+3 digits) |
| 6kΩ   | 0.001kΩ    |                           |
| 60kΩ  | 0.01kΩ     |                           |
| 600kΩ | 0.1kΩ      |                           |
| 6MΩ   | 0.001MΩ    |                           |
| 60MΩ  | 0.01MΩ     | ± (2.0% reading+3 digits) |

Overload protection: 600V DC or 600V AC RMS.

## Diode test

| Range   | Resolution | Accuracy   |
|---|------------|--|
|  | 0.001V     | Displays the approximate value of the forward voltage drop<br>(The open circuit voltage is about 3.0V) |

Overload protection: 600V DC or 600V AC RMS.

## Continuity test

| Range   | Resolution | Accuracy   |
|---|------------|--|
|  | 0.1Ω       | The buzzer will make a noise when it is $\leq 30 \Omega$<br>(Open circuit voltage is about 1V) |

Overload protection: 600V DC or 600V AC RMS.

## Capacitance

| Range | Resolution | Accuracy                  |
|-------|------------|---------------------------|
| 10nF  | 0.001nF    | ± (3.0% reading+5 digits) |
| 100nF | 0.01nF     |                           |
| 1μF   | 0.1nF      |                           |
| 10μF  | 1nF        |                           |
| 100μF | 0.01μF     |                           |
| 1mF   | 0.1μF      | ± (4.0% reading+5 digits) |
| 10mF  | 0.001mF    |                           |
| 100mF | 0.01 mF    | ± (5.0% reading+5 digits) |

Overload protection: 600V DC or 600V AC RMS.

## Frequency

| Range  | Resolution | Accuracy                  |
|--------|------------|---------------------------|
| 10Hz   | 0.001Hz    | ± (0.5% reading+5 digits) |
| 100Hz  | 0.01Hz     |                           |
| 1kHz   | 1Hz        |                           |
| 10kHz  | 0.01kHz    |                           |
| 100kHz | 0.1kHz     |                           |
| 1MHz   | 0.001MHz   |                           |
| 10MHz  | 0.01MHz    |                           |

Frequency measurement range: 10Hz ~ 10MHz.

Signal input : >200mVAC ( RMS ).

Overload protection: 600V DC or 600V AC RMS.



## Duty ratio

| Range  | Resolution | Accuracy                      |
|--------|------------|-------------------------------|
| 1~99 % | 0.1%       | $\pm$ (3.0% reading+2 digits) |

Overload protection: 600V DC or 600V AC RMS.

## Temperature

| Range                         | Resolution | Accuracy                      |
|-------------------------------|------------|-------------------------------|
| -20°C~1000°C<br>(-4°F~1832°F) | 1°C/1°F    | $\pm$ (1.0% reading+2 digits) |

Overload protection: 600V DC or 600V AC RMS.

## Technical Indicators

- Automatic selection of the measuring range of the measuring function.
- Full range overload protection.
- The maximum allowable voltage between the measuring end and the ground: 600V DC or 600V AC.
- Working height: the maximum altitude is 2000m.
- Display: LCD.
- Maximum display value: 5999.
- Polarity indication: automatic indication, "-" indicates negative polarity.
- Over range display: "0L" or "-0L".
- Sampling time: about 3 times/second, about 10 times/second for simulation strip.

- Unit display: display of function and electricity unit.
- Automatic shutdown period: about 10 minutes.
- Power supply: 1.5V SIZE AAA battery × 3.
- Data hold displayed as: "H".
- Battery undervoltage indication: "BAT" displayed on the LCD.
- Temperature coefficient: less than 0.1 × Accuracy/°C.
- Maximum jaw opening size: 23 mm.
- Working temperature: 5 °C~ 35 °C.
- Storage temperature: - 10 °C~ 50 °C.

## Maintenance

- Before opening the back cover of the instrument, the probes should be disconnected from the measuring circuit.
- Only a damp cloth and a small amount of detergent can be used to clean the instrument. Do not use chemical solvents or abrasives to wipe the case.
- To avoid electric shock caused by false readings, replace the battery immediately when the instrument displays "BAT".
- Turn off the power when the instrument is not in use, and turn the function range switch to the "OFF" position.
- If the instrument is not used for a long time, take out the battery to prevent damage to the instrument.
- In case of any abnormality, stop using immediately and send for repair.
- Calibration or maintenance can only be carried out by professionals.

## Battery Replacement



### WARNING

To avoid electric shock, disconnect the probes before opening the battery cover and do not connect to any circuit under test or input signal.

Only replace batteries of the same model or electrical specification.

If the undervoltage symbol, "", appears, it means that the battery is low (the deviation of the measured value in this state is greater) and needs to be replaced. Please follow the steps below:

1. Disconnect the probe from the circuit under test.
2. Turn the function range switch to "OFF" and remove the probes from the inputjack.
3. Unscrew the screws on the battery cover with a screwdriver and remove the battery cover.
4. Take out the 3 used batteries and replace them with 3 new 1.5V SIZE AAA batteries.
5. Cover the battery cover and tighten the screws.